

TCCRX
PROFESSIONAL LINE

INSTRUCTION



TRX 9000 EVO TFT



Cod : TOXPRFTRX9000ET

Rev : 00

Ed : 08/22



18. The equipment is suitable for commercial use. Maximum weight of user :180kg

Warning: Violation of the above safety regulations will cause personal injury and equipment damage.

User's guide

Hardware and tool

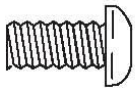

(A8) M10×20
halfround hex
socket bolt
12pcs

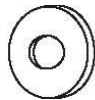

(C2) ϕ 10
flat washer
22pcs

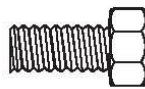

(A4) M10×25
hex bolt
8pcs

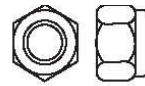

(B1) M10
nylon locking
nut
2pcs



(C5) ϕ 10
spring washer
8pcs

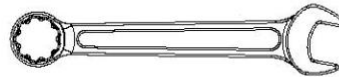

(D2) screwdriver
1pc



(D4) S=8
wrench
1pc
(A17) ST4×16
cross pan head
tapping screw
6pcs

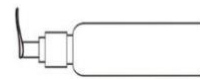

(D5) lubricant
bottle
1pc
(D1) S=17
wrench
1pc

(A9) ST4×30
cross pan head
tapping screw
2pcs

(D3) wrench
(S=6)
1pc

Parts list

No.	Description	Qty
1	Base frame	1
2	Switch base frame	1
3	Incline frame	1
4	Left upright tube	1
5	Right upright tube	1
6	Handlebar and controlling panel	1
7	Display screen	1
9	Front roller	1
10	Rear roller	1
11	10 V belt	1
12	Running board	1
13	Running board cushion	8
14	Rubber mat	8
15	Running belt	1
16	Universal wheel mat	2
17	Left side rail	1
18	Right side rail	1
19	Non-slip colloidal particles	84
20	Position nut	6
21	Shock absorption mat	4
22	Baffle plate	1
23	Motor top cover	1
24	Motor left cover	1
25	Motor right cover	1
26	Motor front cover	1
27	Left end cap	1
28	Right end cap	1
29	Middle end cap	1
30	Rear roller cap	2
31	Motor (AC)	1
32	Incline motor	1
33	Converter	1
34	Emergency stop switch	1
35	Power switch	1
36	socket	1
37	wheel	2
38	Cushion	2

No.	Description	Qty
41	Signal wire A	2
42	Signal wire B	2
43	Signal wire C	2
44	Signal wire D	2
A1	Bolt M8X55	1
A2	Bolt M10X95	1
A3	Bolt M10X55	1
A4	Bolt M10X25	8
A5	Bolt M10X75	4
A6	Bolt M10X165	2
A7	Half-round bolt M8X20	2
A8	Half-round bolt M10X20	10
A9	Crosshead tapping bolt ST4X30	2
A10	Half-round bolt M8X45	6
A11	Half-round bolt M10X60	2
A12	Round bolt M10X90	2
A13	Crosshead screw M8X70	8
A14	Crosshead screw M3X8	2
A15	Crosshead screw M5X40	2
A16	Crosshead screw M5X20	2
A17	Crosshead tapping screw ST4X16	27
B1	Hexagon Nut M8	8
B2	Nylon lock nut M5	2
B3	Nylon lock nut M8	8
B4	Nylon lock nut M10	14
C1	Flat washer ϕ 8	8
C2	Flat washer ϕ 10	24
C3	Big flat washer ϕ 10	4
C4	Flat washer ϕ 5	2
C5	Spring washer ϕ 10	10
C6	Spring washer ϕ 5	2
C7	Nylon Washer ϕ 10	4
D1	Wrench	1
D2	Screwdriver	1
D3	Wrench (s=6)	1

39	Nut cap	4
40	Safety key/emergency button set	1

D4	Wrench (s=8)	1
D5	Lubricant bottle	1

Note: Pls refer to the actual parts if there is difference with the ones in the list.

Installation instruction

WARNING: Don't insert the power wire until the treadmill was fully installed.

Tips:

* To eliminate installation errors, do not tighten all the bolts in each step. Tighten all the bolts after the installation is complete.

* One treadmill is packed in 2 cartons, #1 is for main frame, # 2 is for the handle bar and central controlling panel.

1. Unpack and lift out of the frame

The frame is fixed with a bracket and X, Before leaving the factory, the rack is fixed with a bracket and X, Unscrew the X (there are four in total)mounted on the frame with a wrench. Then lift the frame out. As shown in Figure 1

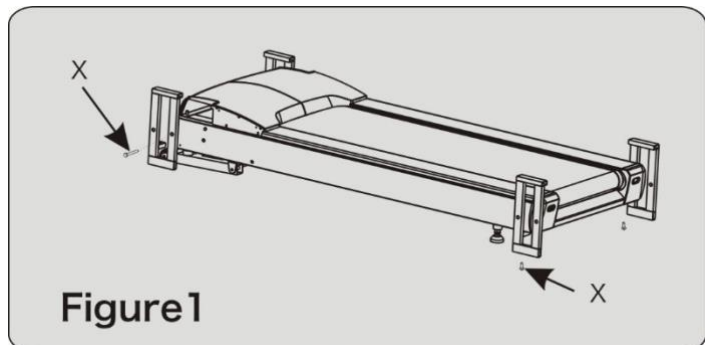

2. Installation of left upright tube

2.1 Install Left upright tube (4) to base frame (1) by four sets of bolt M10X25 (A4), Flat washers $\phi 10$ (C2) by side. (Attention: to align screw hole with the upper surface). Make sure the bolts to connect left upright tube and base frame. (See Figure 2)

2.2 In upper inner side, using one piece of Flat washer $\phi 10$ (C2) and one piece of Nylon lock nut M10 (B4) to tighten. In upper outer side, using Bolt M10X165 (A6) that was assembled on frame to tighten. (Attention: bolt head position is the front underside. See Figure 2-1)

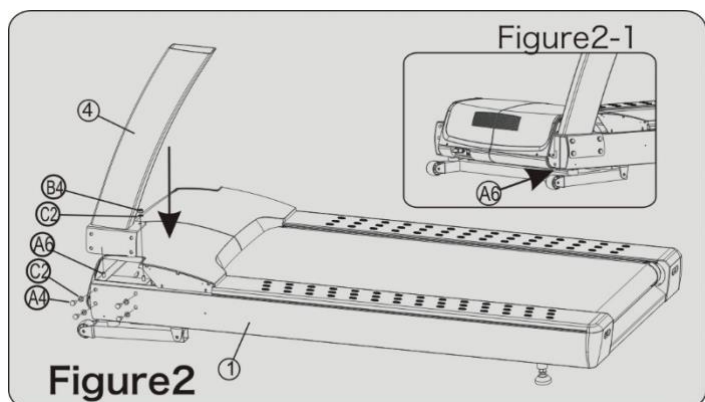

3. Installation of right upright tube

3.1 Connect the Signal wire from right upright tube to corresponding wires from frame.

3.2 Install the Right upright tube (5) to base frame (1) using four sets of bolt M10X25 (A4), Flat washers $\phi 10$ (C2) by side. (Attention: to align screw hole with the upper surface). Make sure the bolts to connect right upright tube and base frame. (See Figure 3)

3.3 In upper inner side, using one piece of Flat washer $\phi 10$ (C2) and one piece of Nylon lock nut M10 (B4) to tighten. In upper outer side, using Bolt M10X165 (A6) that was assembled on frame to tighten. (Attention: bolt head position is the front underside. See Figure 3-1)

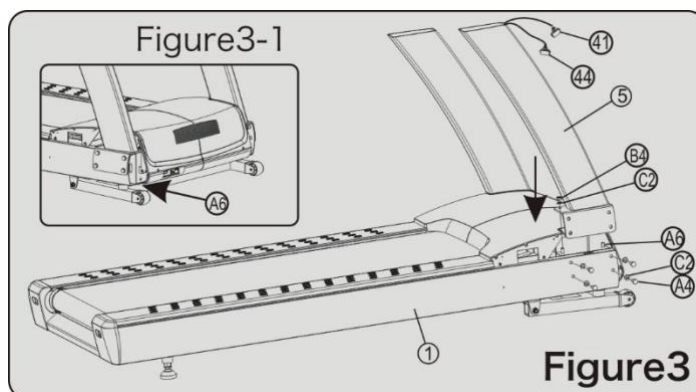

4. Installation of handlebar and controlling panel

4.1 Connect the Signal wire from Right upright tube to corresponding wires from Handlebar.

4.2 Install handlebar and controlling panel set (6) to the Left/Right upright tube (4/5).

4.3 Connect handlebar and controlling panel (6) to the Left/Right upright tube (4/5) by 8 sets of Half-round bolt M10X20 (A8), Spring washer $\phi 10$ (C5), Flat washer $\phi 10$ (C2). (Attention: To align screw hole) (See Figure 4)

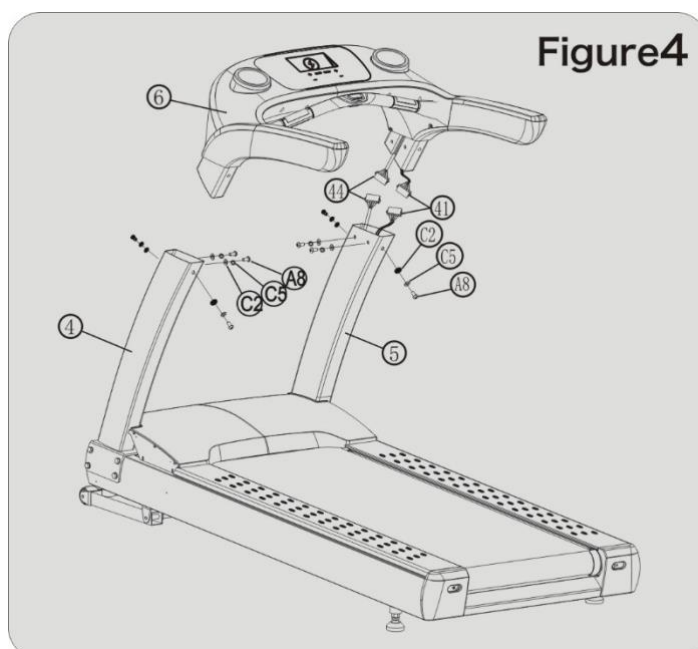

5. Installation of display screen

5.1 Connect the signal wire from display screen to corresponding wire from controlling panel. Crowding the extra wire into the panel.

5.2 Connect the display screen (7) to handlebar and controlling panel (6) by 4 sets of Half-round bolt M10X20 (A8), Flat washers $\phi 10$ (C2). (Attention: To align screw hole) (See Figure 5)

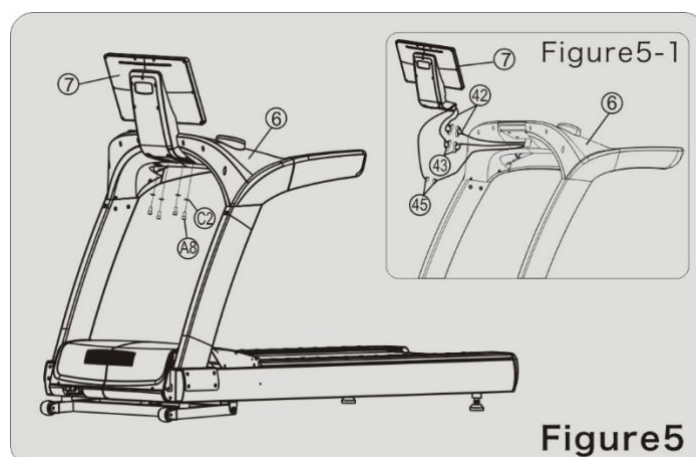

6. Installation of motor left/right cover

6.1 Tighten all the installation bolts

6.2 Install motor left cover (24) to top motor cover (23) of base frame (1) by 1pc of Crosshead self-lock bolt ST4X30 (A9) in front and 3pcs Crosshead self-lock bolt ST4X16 (A17) to tighten.

6.3 Install motor right cover(25) to top cover(23) of base frame (1) by 1pc of Crosshead self-lock bolt ST4X30 (A9) in front and 3pcs Crosshead self-lock bolt ST4X16(A17) to tighten.(See Figure 6)



WARNING: Improper connection of the grounding conductor may cause electric shock.

If you' re not sure whether the device is properly grounded, please turn to a professional electrician or repairman to inspect. Do not modify the plug supplied with the product, if the plug does not match the socket, you should turn to a professional electrician to install a proper socket.

Adjustment instruction

1. Before connecting power, service or professional personel should check whether voltage is appropriated, and whether the ground wire of three-core plug is wellconnected. Pull the running belt by hand, check whether the rotation is flexible, there is no abnormal sound.
2. Connect power, press Start key, the treadmill starts to run in low speed,observe whether belt and computer are run normally.
3. Press the speed up and down key to observe the rotation and display of the treadmill. If the belt deviated, stop the treadmill and adjust the running belt according to the requirements of "maintenance".
- 4.Press emergency stop key or pull out safety key,the treadmill will stop immediately. Re-inset the emergency stop key to reset or insert safety key, can restart treadmill. (As below figure)
- 5.Press Stop key, the treadmill stop running, then turn off the power when the incline returns to zero .

Treadmill can be put into use after all the installation adjustment is completed.

1.1. Two feet stand on two side of belt, put the other side clip from safety key to clip to clothes. (see the figure)

2. Press Start key, the treadmill will start running at lowest speed. You can step on the belt and walk slowly.

3. Press speed+ key, the speed of running belt will gradually increase, you can see the speed value from computer, start to run at low speed for 2-3 minutes, then increase the speed to your target, you can release the handlebar after after run is suitable, you can let go handrail to run after adaptation.

4. When stopping running, you should slow down gradually and run for 2-3 minutes at a low speed, so that the heart and breathing slowly return to normal.

5. After running, you can reduce speed to the minimum, and then press the start/stop button to stop the treadmill.

6. If running at high speed, it is too late to slow down, or even lose balance, you can press the emergency stop button, and the treadmill can stop running immediately. The stopping distance depends on the inertial weight.

7. Please fully master the use of emergency stop button and safety key.

8. If the emergency stop button and safety key fail or are damaged, they must be maintained or replaced by professionals in time. (They are easily worn parts)

9. Noise under load is higher than that without load.

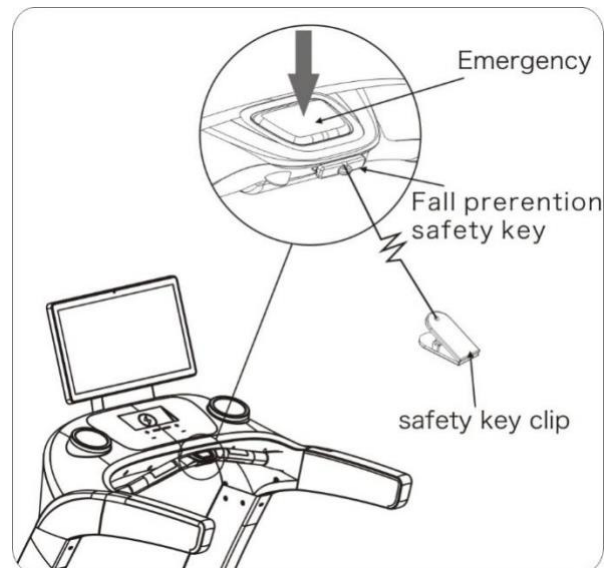

WARNING: Frequent use of incline operation (more than 5 times in a row) may render the incline ineffective. It's not a malfunction. It is a kind of automatic protection of inclinemotor, the function will be restored automatically after 1 hour stop using.

TFT instruction

WARNING: To reduce the possibility of electric shock, keep the console dry. To prevent liquid from spilling onto the console, only sealed water bottles can be placed on the water bottle holder.

1. Quick start

The treadmill adopts 21.5 inch high resolution touch screen to display the data and sports state during exercise, and installs multimedia APP application and running training

mode to make sports entertainment more rich and interesting. Power on, turn on the main power switch of the treadmill, install the safety switch key then enter into the main menu as shown below

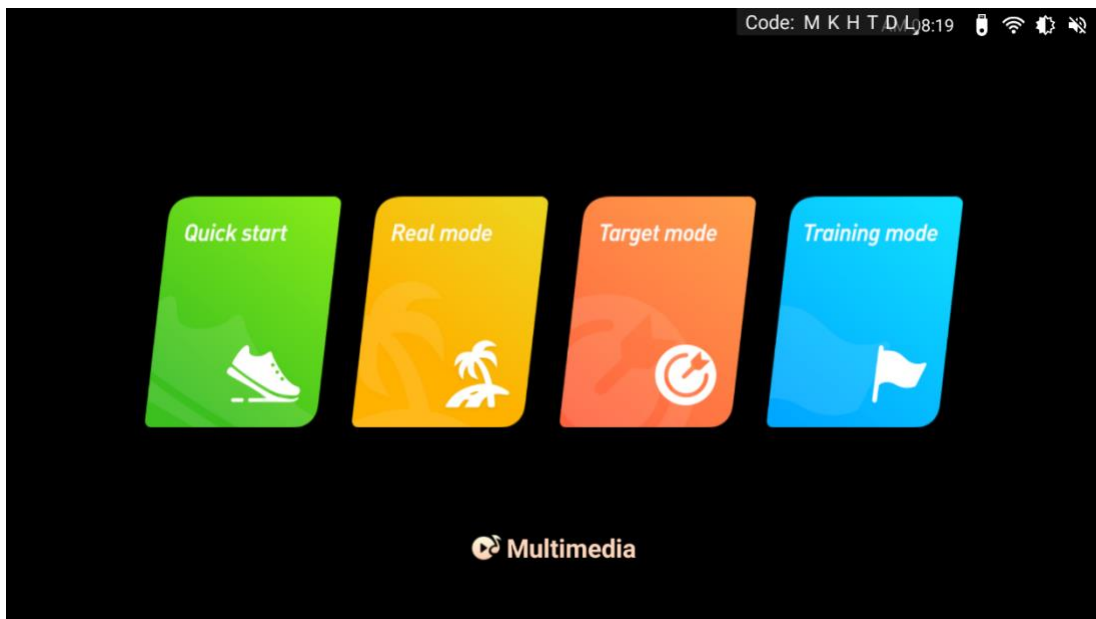



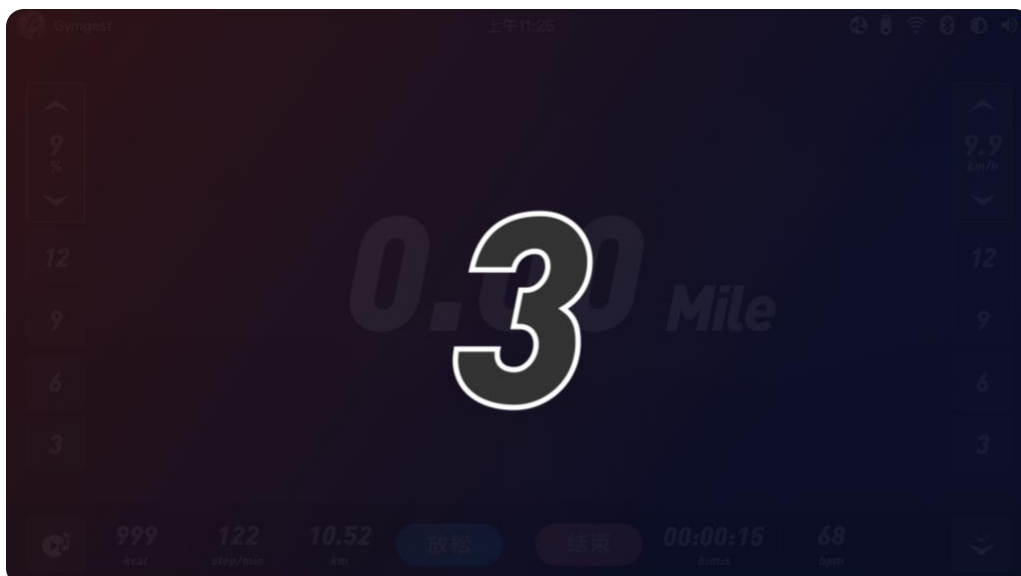

Click the "Quick Start" on the screen or the "START" button on the console to start quickly. The treadmill will directly start the countdown and enter running mode as shown below:

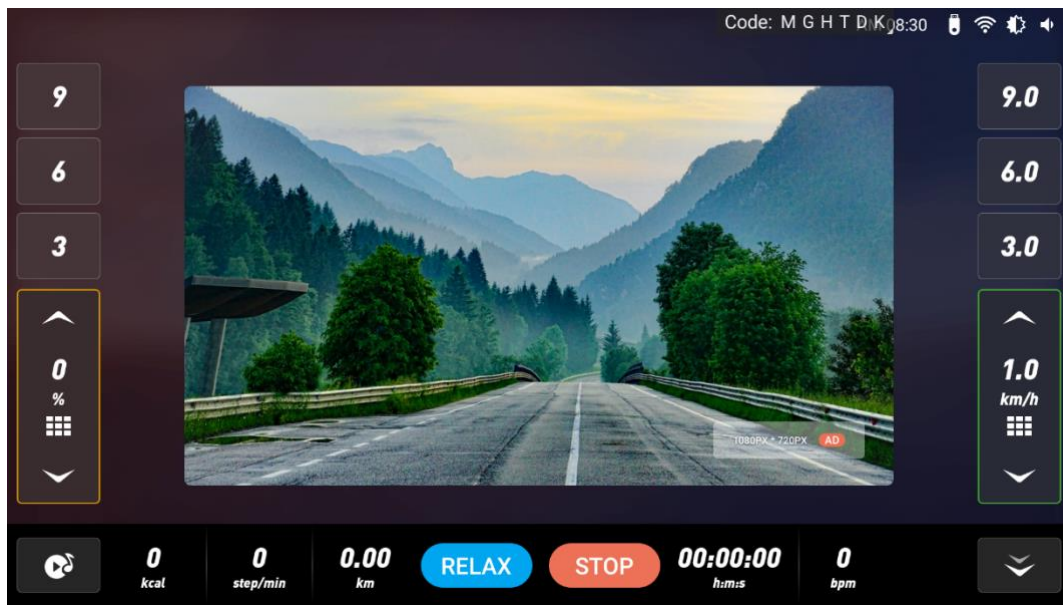



Main interface in running state is shown as below:

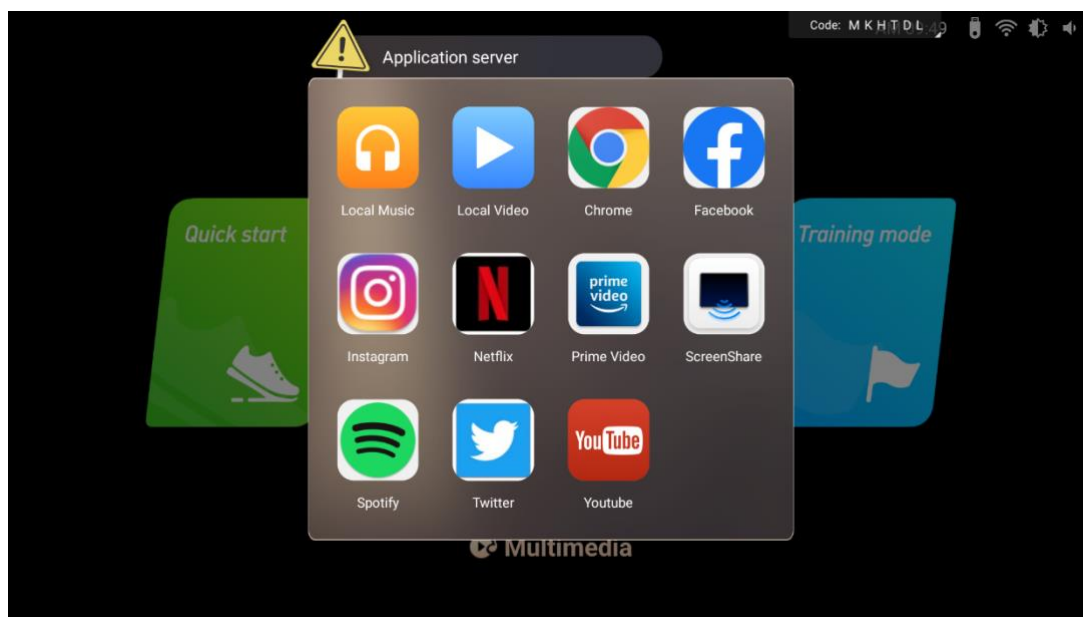

After starting the treadmill, press the speed adjustment button (+ -/ ) on the controlling panel or color screen to adjust your running speed. Press the incline adjustment key (+ -/ ) to adjust the comfortable running incline; Press the speed direct selection key (3-6-9) or fast selection key  on the screen to quickly select the speed; Press incline direct selection button (3-6-9) or quick selection button () on the screen to quickly select the incline. For your safety, try not to operate other functions on the screen when running. If you want to operate the media APP function , please do it when it is lower than 3KM/H or in the shutdown state. Click the "multimedia" icon on the interface to enter the APP interface, as shown in the picture below, you can browse Twitter, Facebook... and so on.



When the speed is > 1KM/H, click the "  ", the speed will be reduced to a comfortable state and the incline to the initial state value. When you want to stop running, press the "  " on

the home page or the "STOP" button on the controlling panel, and a window that is about to end running will pop up on the home page to provide "Keep on running" or "Stop", as shown below:

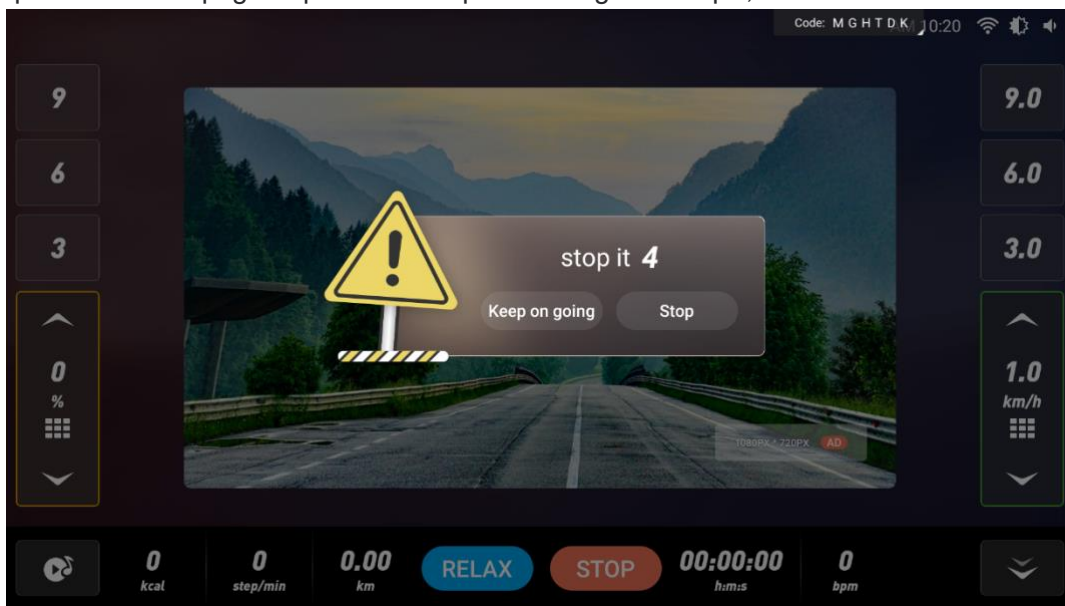

If you need to stop running in an emergency, please pull out the safety key or press the emergency stop button to stop the treadmill. Then it will be shown as below:

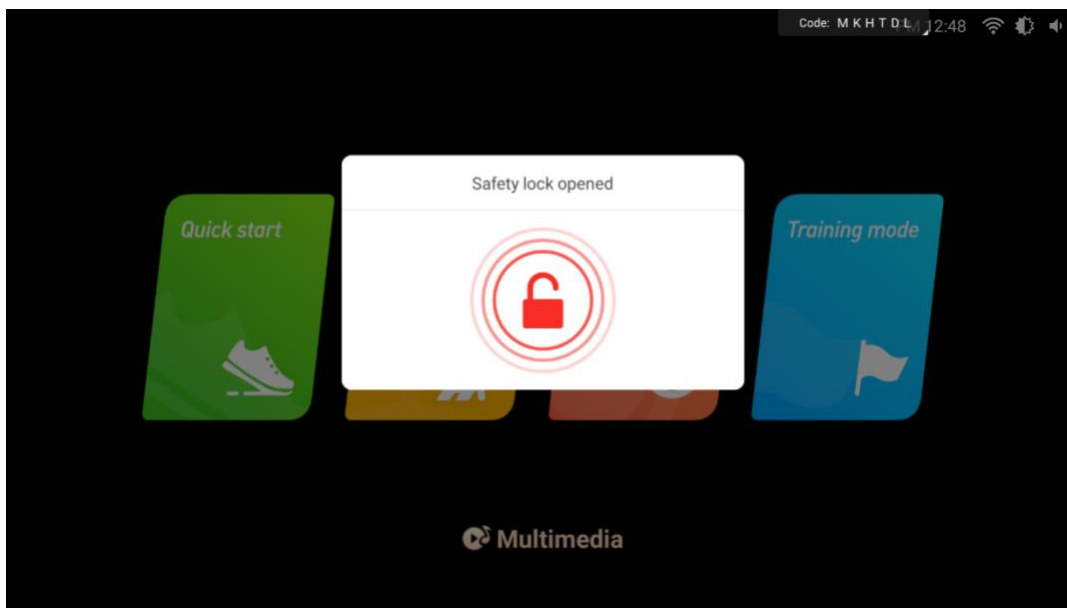

After inserting the safety key, it will switch to the main menu page, as shown below:

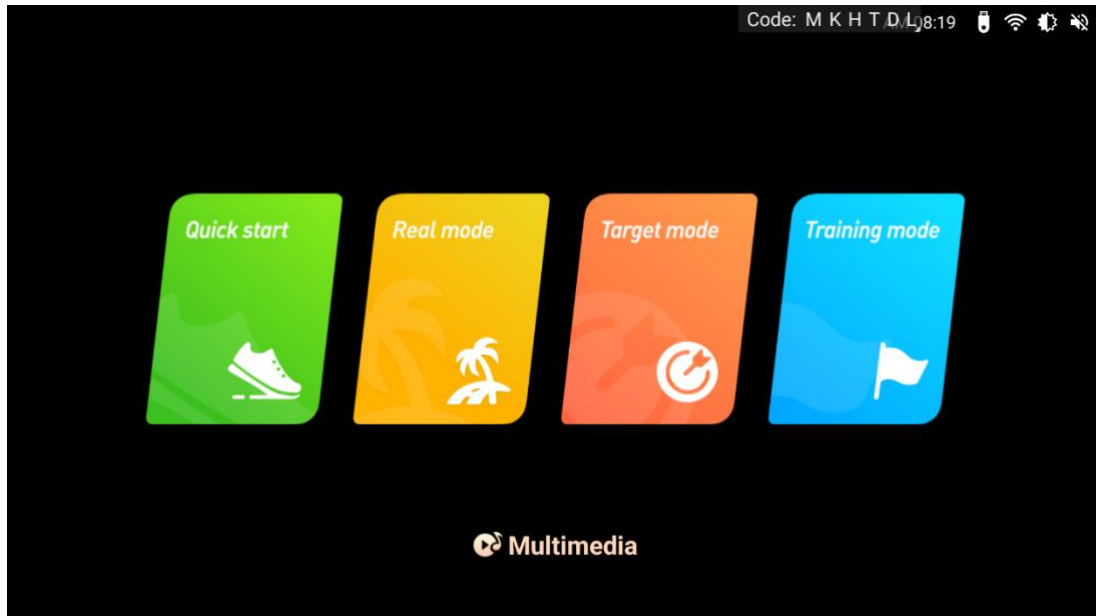

In the standby mode, you can choose the Quick start mode, Real mode, Target mode, Training mode and other sports programs to train, and you can also choose Multimedia for other operations.

2. Controlling panel instruction

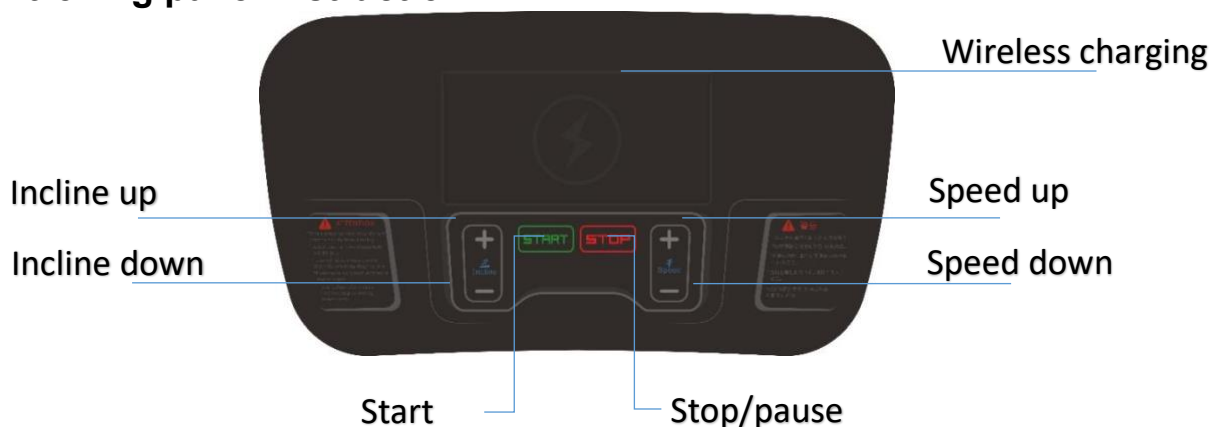

2.1 Mechanical button operation

START Start: after power on, press “START”,the treadmill starts running.

STOP Stop/pause: press this button when running, the treadmill will puase, and press again to stop running. After the pause, press the start button and the treadmill will return to the running state before the pause.

+ Speed adjustment: when the treadmill is running, press this key to adjust the speed, keep pressing will lead to fast adjustment.

+ Incline adjustment: when the treadmill is running, press this key to adjust the incline, keep pressing will lead to fast adjustment.

Emergency stop button/Safety key: it is a safety device to prevent slipping or forced shutdown in emergency. When using the treadmill, you need to insert the safety key inward (after inserting the safety key, the emergency stop button will automatically reset and spring up), press the emergency stop button or pull out the safety key side of the treadmill to stop running.

⚡ Wireless charging: when the treadmill is powered on, if the mobile phone has wireless

charging function, put the mobile phone in the charging slot, and the wireless charging can play.

2.2 Buttons in touch screen

2.2.1  Quick start: when the treadmill is powered on, click this button then the Treadmill starts to run.

2.2.2  Real mode:click this button to enter the real scene selection interface.

2.2.3  Target mode:click this button to enter the target selection interface.

2.2.4  Training mode: click this button to enter the training selection interface.

2.2.5  Multimedia: click this button to view different applications.

2.2.6  :click this button to return to the previous menu.

2.2.7  :click this button to switch to the full screen.

2.2.8  : click this button to switch to the initial interface.

2.2.9  Stop: click this button to stop running the treadmill.

2.2.10  Cool down: Click this button to reduce the treadmill speed/incline to the initial state of comfortable exercise.

2.2.11  Speed/Incline up: click this button to increase running speed / incline.

2.2.12  Speed/Incline down:click this button to decrease running speed/incline.

2.2.13  Quick speed selection: click this button to enter quick speed selection.

2.2.14  Quick incline selection:click this button to enter quick incline selection.

3. Display screen instruction



4. Instruction of running programs and setting operation

4.1 Treadmill operation instruction

Switch on the power, the treadmill enters the standby state, press "START", the treadmill starts to run, you can choose the speed or incline button to adjust, press "STOP" to stop running. In the standby state, if there is no signal input for a long time, the treadmill enters the black screen of shutdown standby state. Press any physical mechanical button to light up the screen and return to the standby. Before starting the treadmill, you can choose system settings or training mode.

4.2 Status bar and shortcut Settings

Under the power-on state, you can set the system. Through the status bar and shortcut setting area in the upper right corner of the home page, you can open the shortcut setting menu, adjust the treadmill volume, screen brightness and set bluetooth. Advanced Settings are the management menu of treadmill, it is non-user menu, but only for equipment maintenance personnel. As shown below:

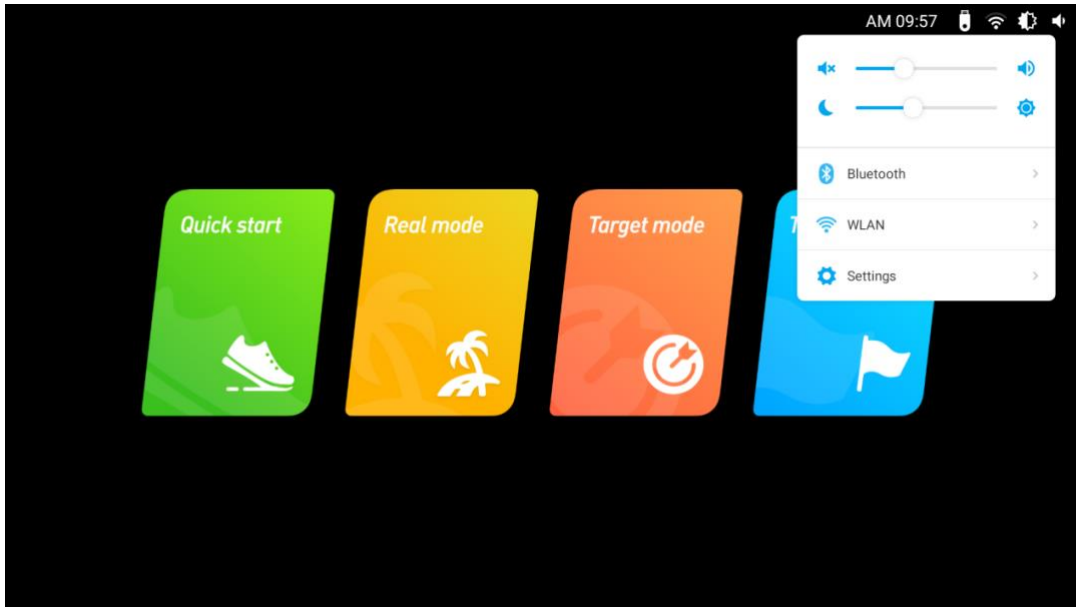

4.3 Real mode

Click "REAL MODE" on the screen, the treadmill enters the real scene selection interface with six built-in scenes, as shown below:

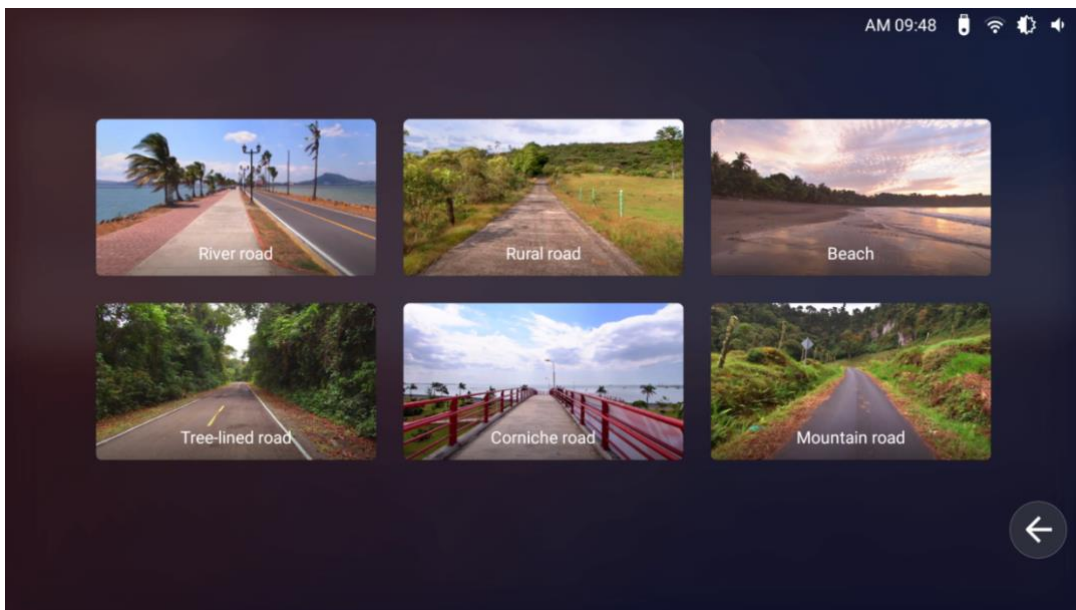

Users can choose their favorite real scene, click to enter the scene running. For example: the user chooses "Beach" real scene, beach scene running will be started. As shown below:

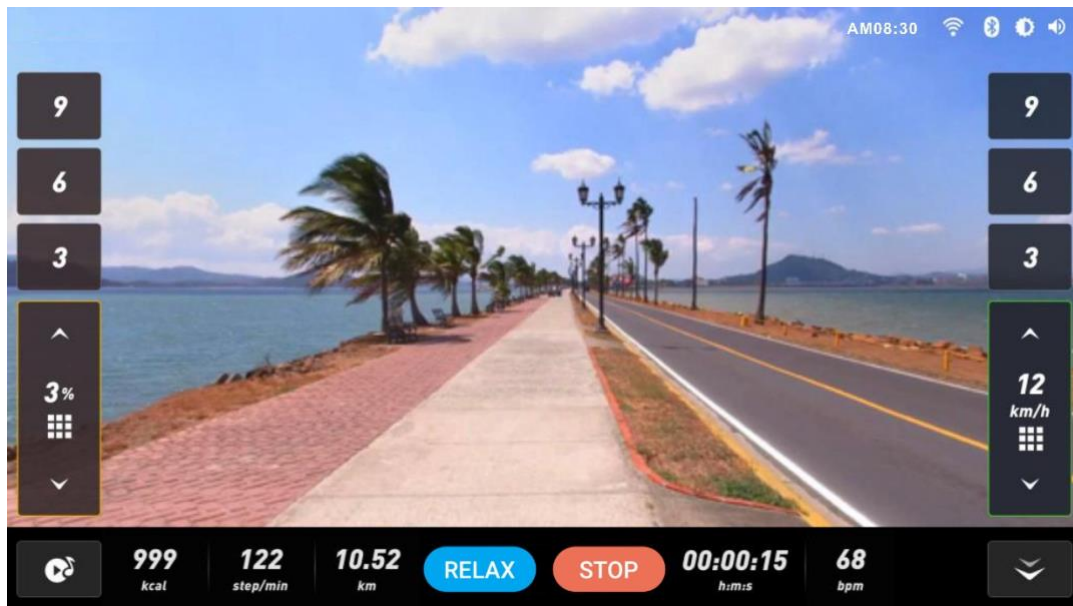

Press the speed adjustment button (+ -/⬆️) on the controlling panel or screen to adjust the speed of running. Press the speed direct selection key (3-6-9) or fast selection key (1.0 km/h) on the screen to quickly select the speed. Note: In the real running mode, there is no need to adjust the incline. The system will automatically set it according to the terrain changes in the real scene.

4.4 Target mode

Click "TARGET MODE" to enter the target selection interface, which has three types, as shown below:

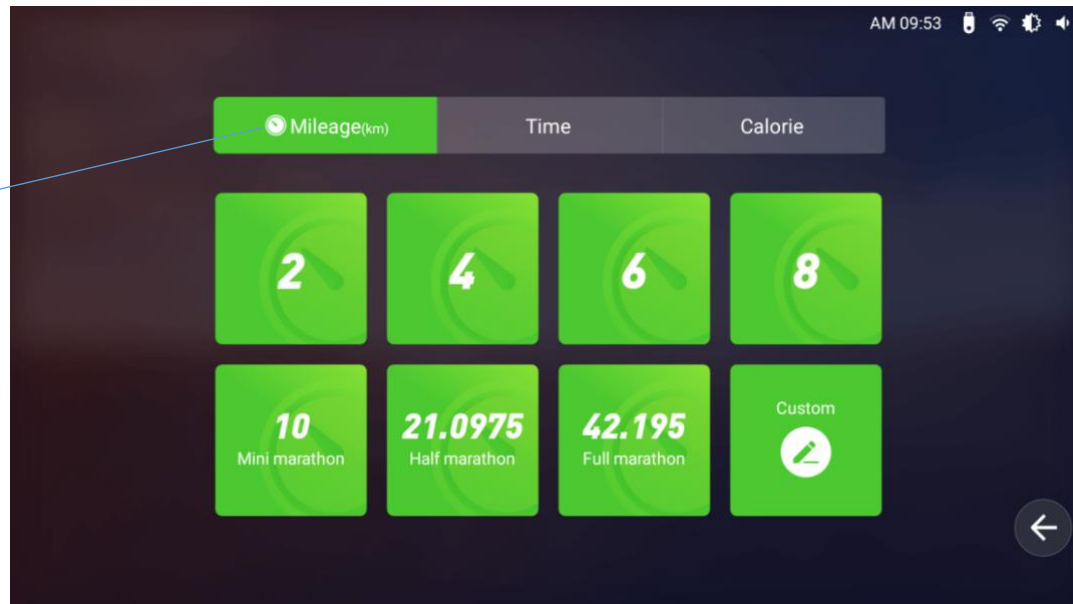

4.4.1 **Distance**: Built-in 2/4/6/8/ Mini marathon/half marathon/full marathon/custom options. The distance will gradually decrease as you run, then come to end when it drop to 0.

Users can select their target distance and click to enter the running interface. For example, users can select a "4km" to start . As shown below:

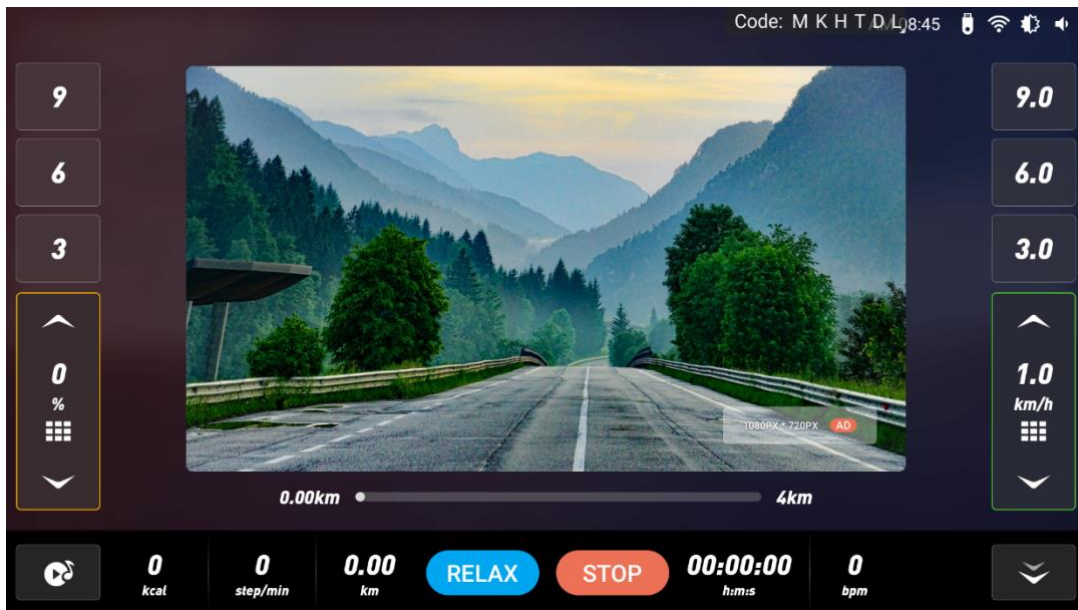

Cutom mode: Press the button to enter the setting interface. After setting, click "Start running" to run. As shown below:

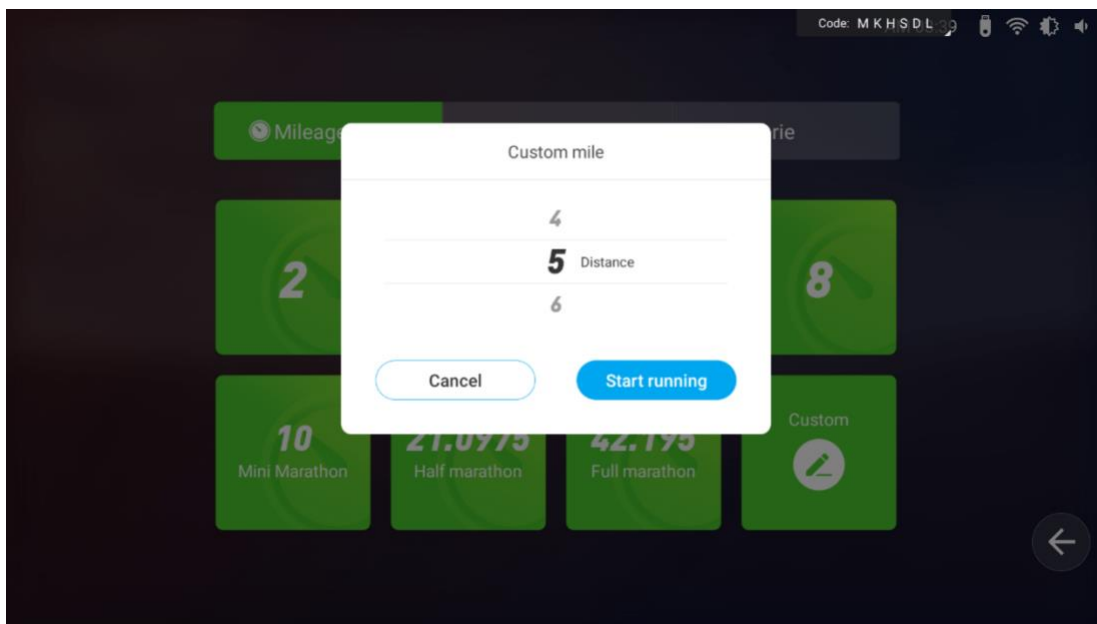

4.4.2 Time: Built-in 15/30/45/60/90/120/150/custom options. The setting time will gradually decrease as you run, then come to end when it reaches 0.

Users can select their target time and click to enter the running interface. For example, the user selects the "15 minute" to start. As shown below:

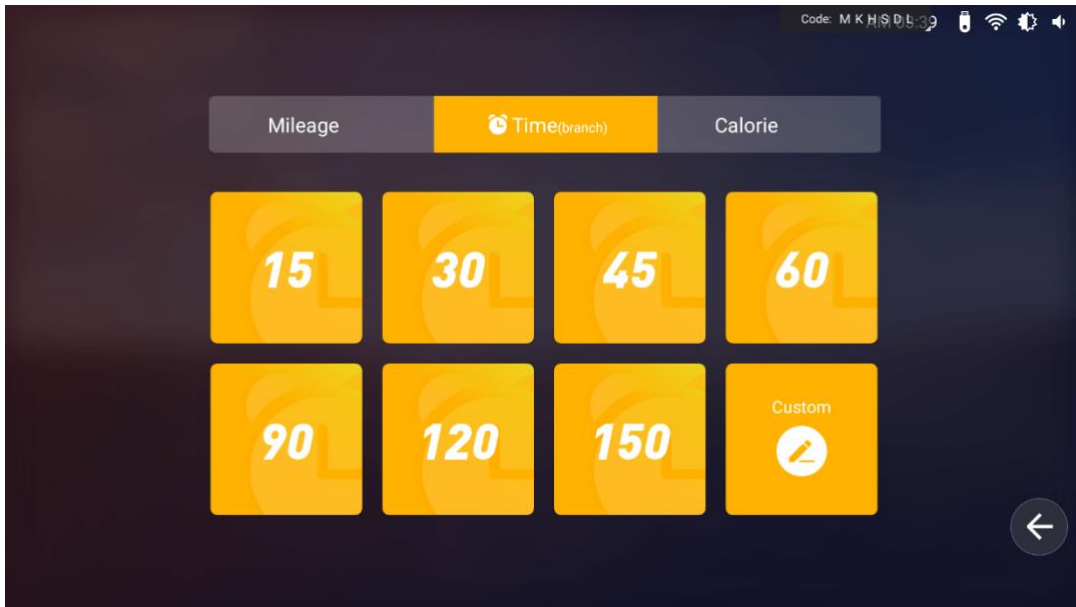

Custom mode: Press "Custom" to enter the setting interface. After setting, click "Start running" to run. As shown below:

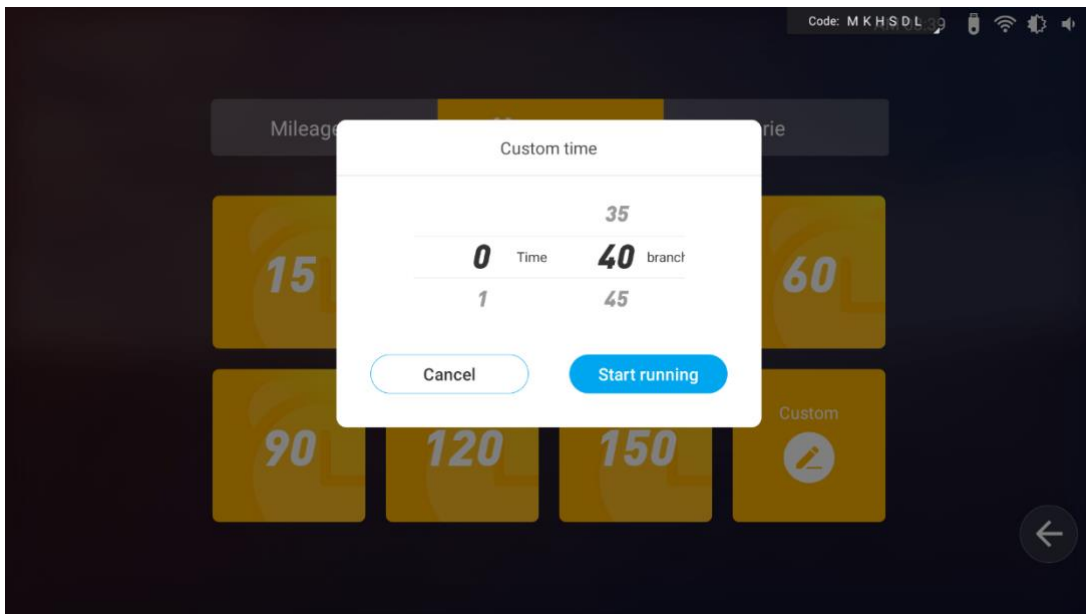

4.4.3 Calorie: Built-in for 100/200/300/400/500/1000/1500 / custom options. The setting calories will gradually decrease as you run, then come to end when it reaches 0. Users can select their target calorie and click to enter the running interface. For example, the user selects the "100" to start. As shown below:

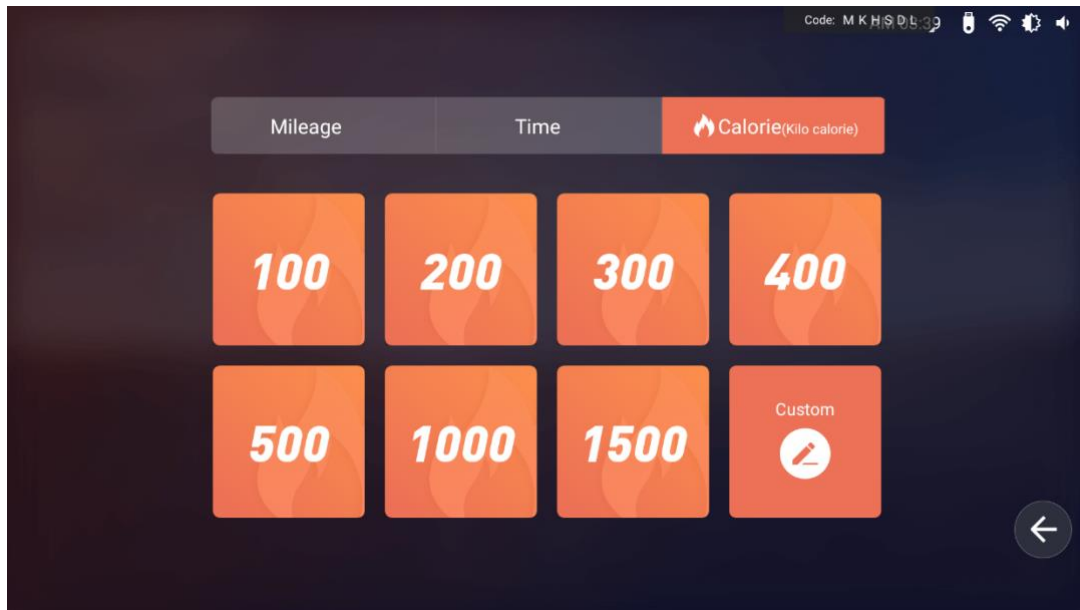

Custom mode: Press "Custom" to enter the setting interface. After setting, click "Start running" to run. As shown below:

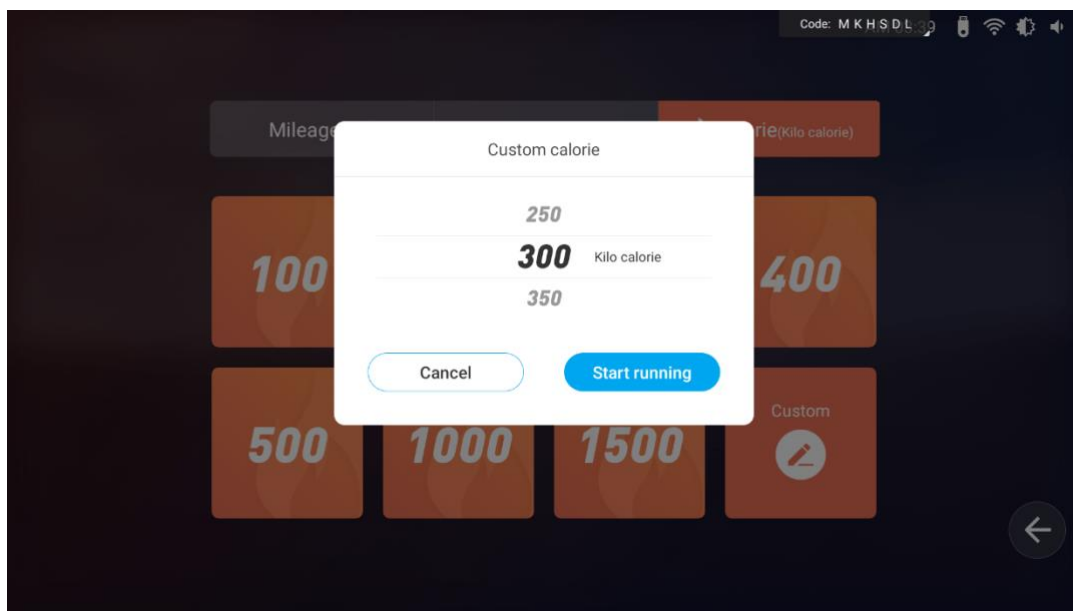

4.5 Training mode

Click "Training mode" to enter the selection interface, as shown below:

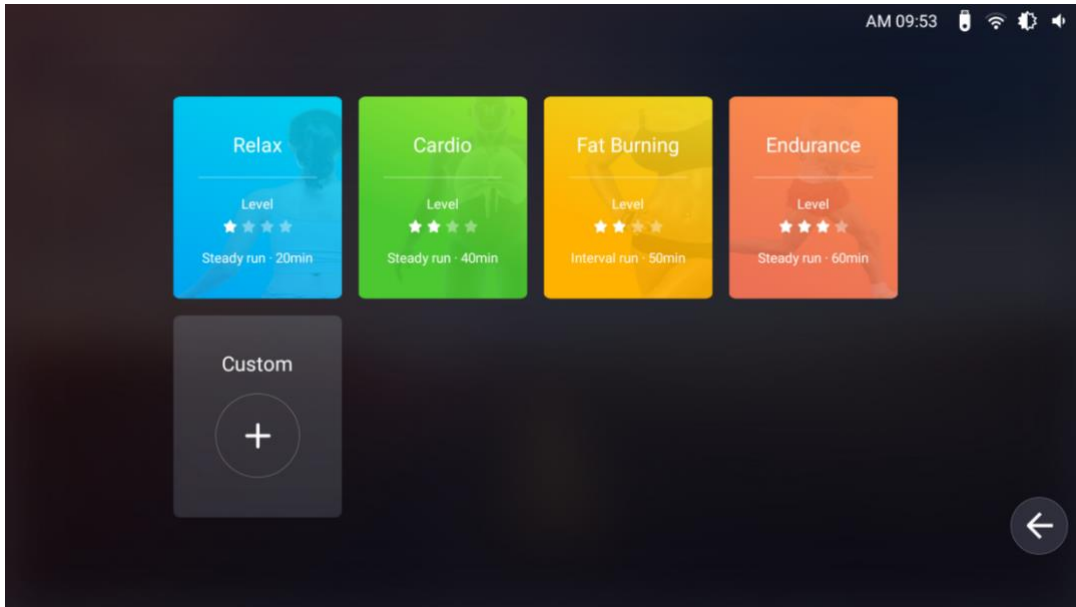

4.5.1 In the training mode, the system provides a variety of preset training plans of Relax, Cardio, Fat burning and Endurance for different running styles to help train stretching. Different running modes have different incline and paces, so users can concentrate on running without worrying about various Settings.

Users can select the training mode and click to enter the running interface. For example, when users select "Relax", they can start running in this mode. As shown below:

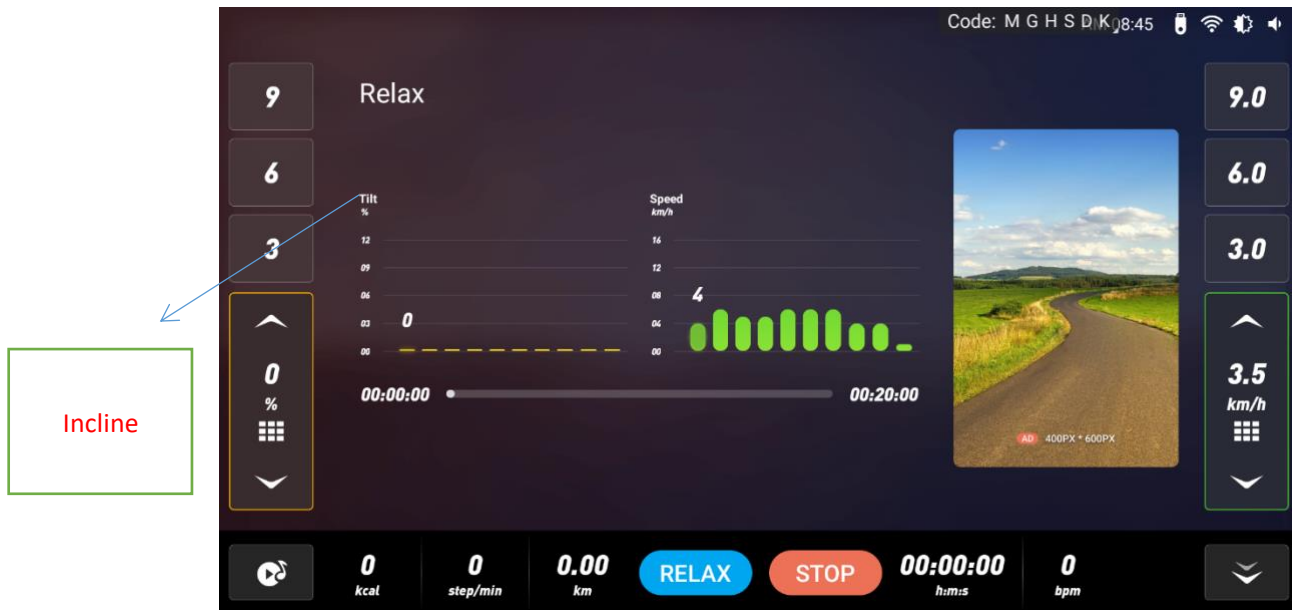

4.5.2 Custom mode: If the preset training mode cannot meet users' requirements, they can customize the training mode, including: running duration, incline and speed of each running stage. You can press and drag any rectangular bar to set different incline changes and different pace parameters in different time periods. After setting, click "START" to run, as shown below:

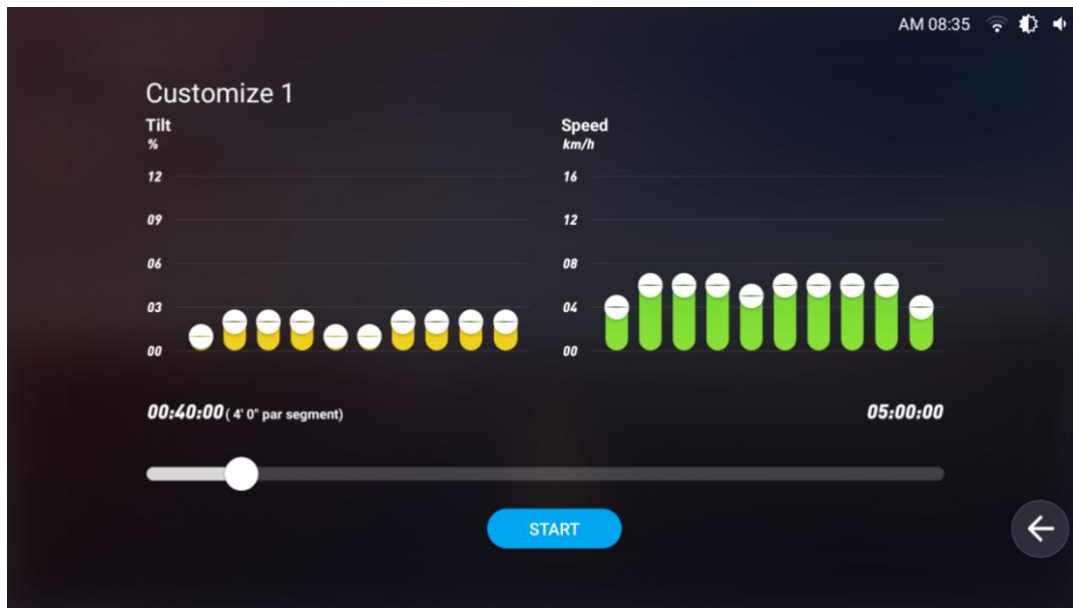

5. Multimedia

Click “Multimedia” to enter application selection interface , as shown below:

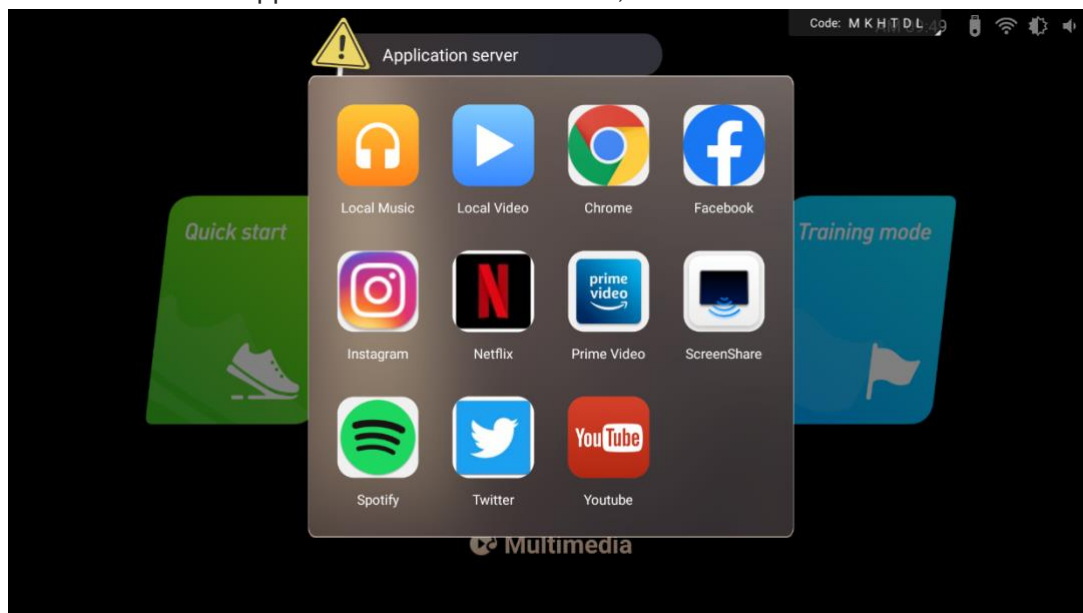

*Remark: Because the software is constantly updated and iterated, if the actual interface is inconsistent with that in this instruction, the actual interface prevails, this document is for reference only.

◆ Heat rate test

The test can detect static and dynamic heart rate before and after exercise, and recovery after exercise. The user holds the metal plate of heart rate detection on the left and right horizon handlebar with both hands, then the heart rate value will be displayed on the screen. (Warm reminder: the maximum heart rate of the exerciser should not exceed (220- age). When the heart rate exceeds the maximum, it is recommended to rest for about 30 minutes or slow down and reduce the incline. The detected heart rate

is only for the reference of sports and fitness.

Warning: Heart rate monitoring system may be inaccurate. Excessive exercise can result in serious injury or death. Stop exercising immediately if you feel faint.

◆Interface instruction

1. Audio input

When walking, you can wear headphones and plug the earphone into the audio port to listen to the voice on the headphones.

2. USB input

Insert the USB flash drive into the port on the right of the display, and click the multimedia to play songs and videos on the USB in Local Music and Video.

3. Bluetooth

The bluetooth of this treadmill is set as the main device, which can recognize and connect bluetooth speakers, earphones and other bluetooth peripheral.

4. ScreenShare

4.1 Enter multimedia - click ScreenShare - scan QR code to download the assistant application in your mobile phone;

4.2 Open the share application in your mobile phone;

4.3 Follow the instructions to operate in your mobile phone, then the touch screen can be shared in your mobile phone.

5. FIT APP instruction (if have)

5.1 Scan the QR code to download the "FIT"application in your mobile phone or tablet PC.

5.2 Turn on bluetooth in your mobile phone or tablet PC;

5.3 Turn on the treadmill;

5.4 Connet the treadmill.



Maintenance and malfunction treatment

1. Clean: The surface of the treadmill should be kept clean, pull out the power cord before cleaning. You can clean the running belt and the surface of the treadmill with a soft and wet cloth, be sure not to use strong solvents.

2. Adjustment of belt deviation: The running belt has been adjusted when manufactured; it may runs defectively after transportation and use. Turn off the treadmill before adjusting, (see figure) adjust the left and right bolts in rear roller with wrench

If the belt deviates to the left, clockwise rotate the left bolt. If the belt deviates to the right, counterclockwise rotate the right bolt. It is better to adjust 1/2 circle at a time. After adjustment, turn on the power and start the treadmill to check if the belt back to center at speed of 4-5km/h, repeat the procedure if not.

3. Adjustment of belt slip: After a certain time of using, the belt might turn to be longer or couldn't free roll..

Your should adjust the left and right bolts in rear roller clockwise at same position till it runs smoothly and freely, it is better to adjust 1/2 circle at a time .But to avoid shortening belt using lifetime, do not adjust it too tight.

4. Lubricate

After using over 100 hours or the lubricant between the running board and the running belt is used up, please lubricate the running board and adjust the running belt well.

4.1 Power off, loose the belt by using the method of belt deviation adjustment, then brush lubricant to the running board evenly.

4.2 Please do not lubricate excessively, lubricant is not the more the better, reasonable lubrication can improve the service life of the treadmill.

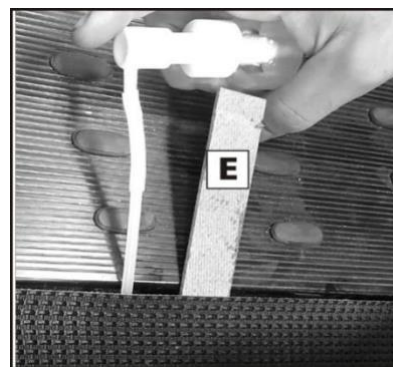
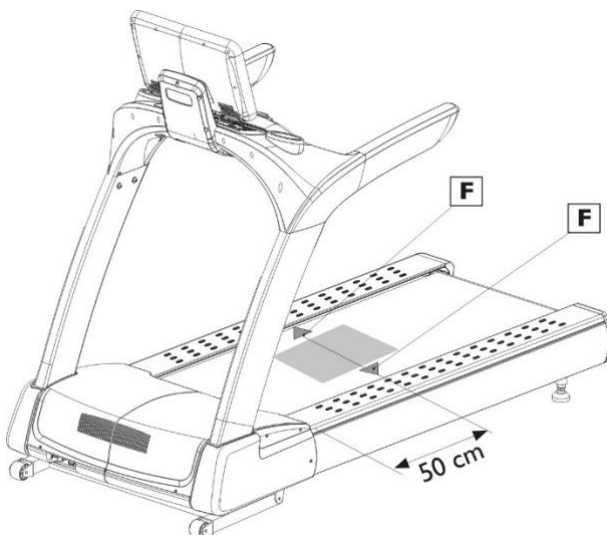
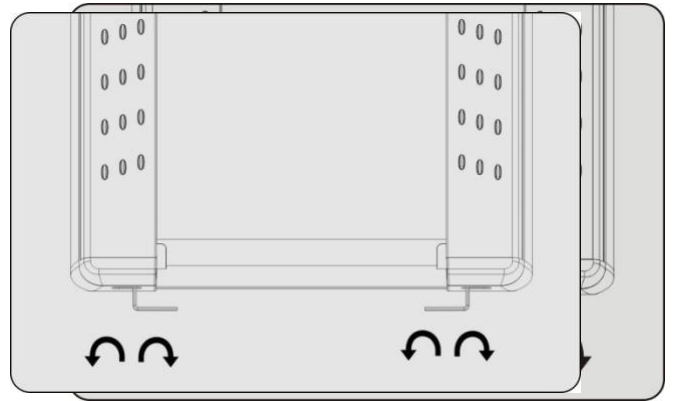



GARLANDO SPA
Via Regione Piemonte, 32 - Zona Industriale D1
15068 - Pozzolo Formigaro (AL) - Italy
www.toorx.it - info@toorx.it